

Product datasheet

Captair 483 Smart

Ductless filtering fume hoods

Safer to operate

- Exclusive Erlab filtration technology combining activated carbon and HEPA/ULPA to adapt to the manipulation
- Meets AFNOR NFX 15 211/ANSI Z9.5-2012 filtration efficiency standard (class 1 and 2)
- Real time sensors to detect main filter saturation with solvents, acids or formaldehyde
- Safety filter in case of main filter saturation
- Air face velocity permanent monitoring
- Erlab Safety Program: application analysis and validation, usage framework certification, usage follow-up
- Connected device allowing reception of safety notifications and use status

Simpler to use

Real time status communication by light and sound pulses:

- Air face velocity decrease
- Main filter saturation
- Fan failure
- Excess scheduled working time

Flexibility

- Modular filtration column adapting to application changes
- Easy and fast relocation

Savings

- No ductwork cost
- Annual energy cost < 100 €
- Compared to an extraction fume cupboard, energy savings compensate filter replacement cost

Environment

- No chemical release into the atmosphere
- Low energy consumption



Ask for the highest level of filtration performances

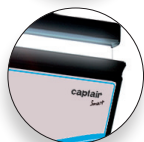

Powerful light guided communication



Connect your equipment and benefit from the remote access thanks to our mobile solutions



Download our eGuard application

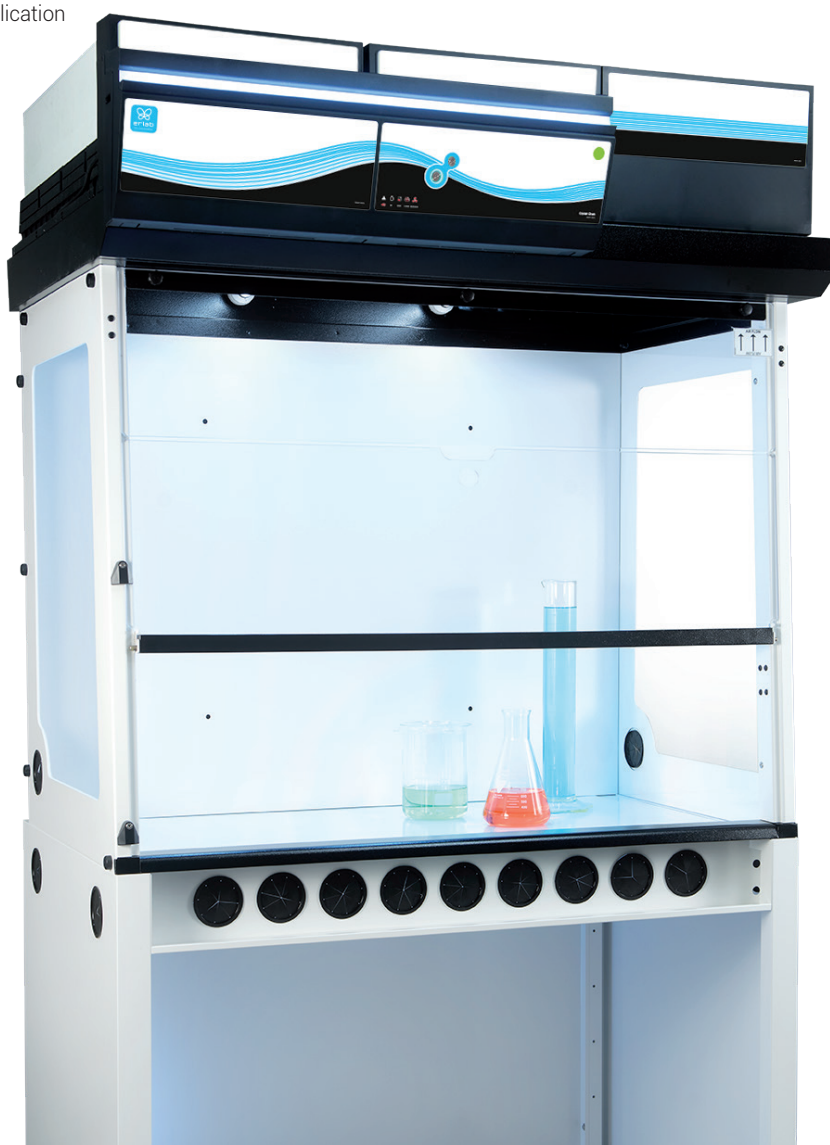

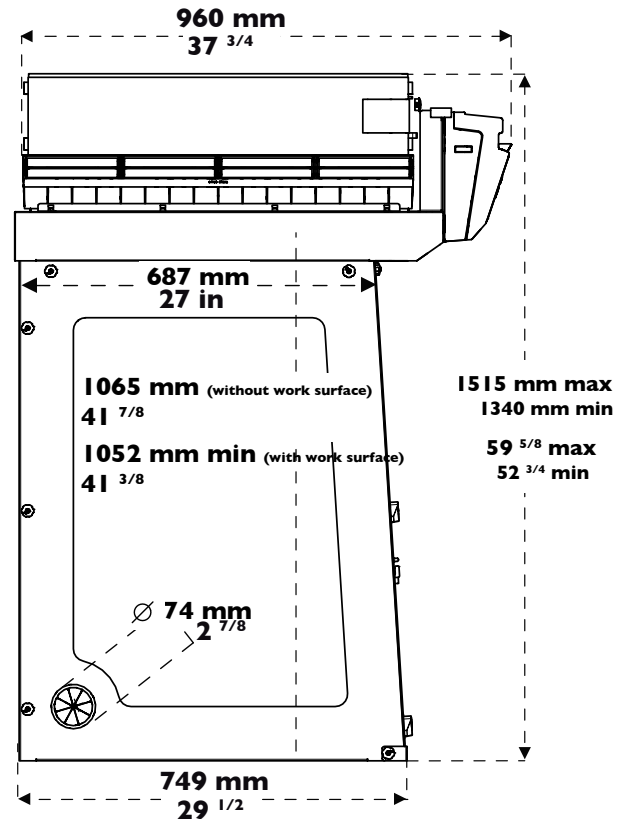
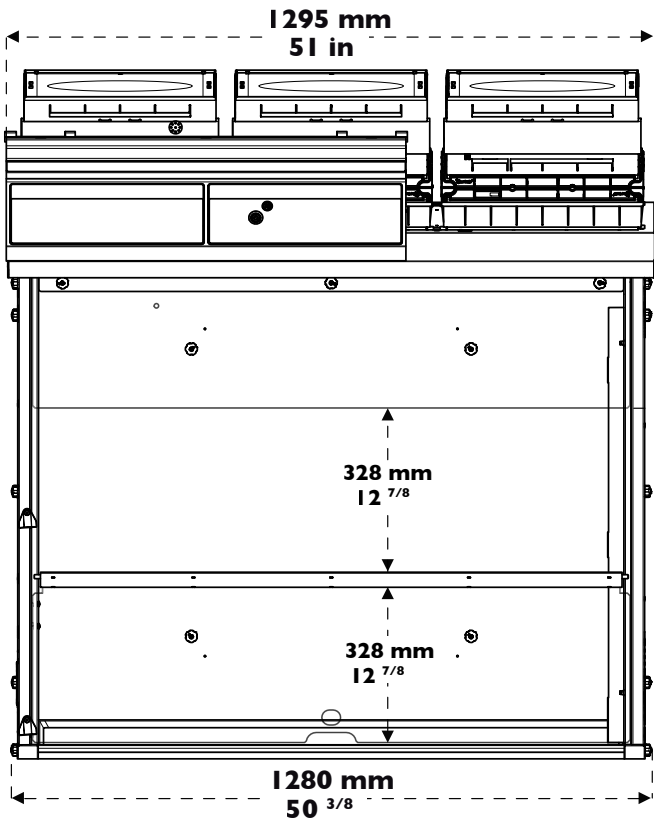

Heights according to the filtration column configuration		
Type 1C or 1P	1340 mm	Please add 150mm between the last filter and the ceiling to allow a good air recirculation and to replace filters easily
Type 2C or 1P1C or 1C1P	1435 mm	
Type 1P2C or 1P1C1P	1515 mm	

Work surfaces with built in spill tray

Tempered glass

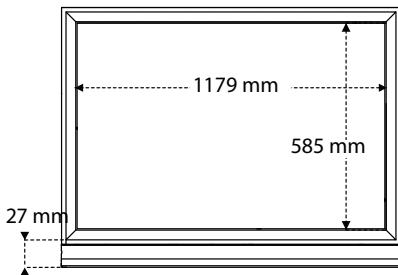

Trespa® Top Lab^{PLUS}

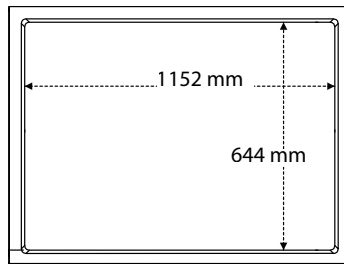

304 L stainless steel

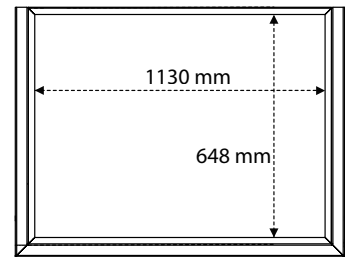

Benchcap: fixed work bench

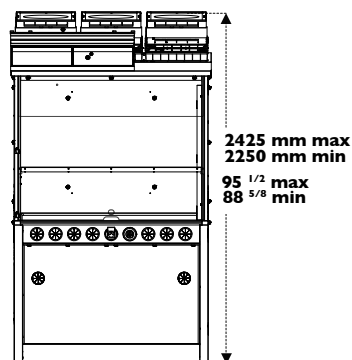

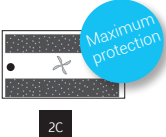
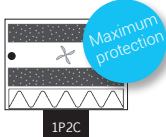
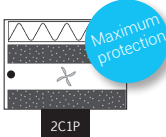
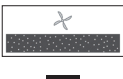
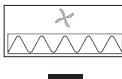
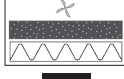
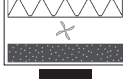

Modular design of the filtration column allows to adapt to every protection needs

		Products handled / Applications			
		Liquid chemicals handlings	Powders handlings	Liquid chemicals and powders handlings	Liquid chemicals handlings in clean room
Customized filtration column	Class 1 according to the NF X 15-211		NA		
	Class 2 according to the NF X 15-211				

Available filters :



Carbon filtration for gases and vapours

AS: For organic vapours
BE+: Polyvalent for acid + organic vapours
F: For formaldehyde vapours
K: For ammonia vapours



Particulate filtration for powders

HEPA H14: 99.995 % efficiency filtration of particles over 0.1 µm in size
ULPA U17: 99.999995 % efficiency filtration of particles over 0.1 µm in size



Ventilation

- **Molecode**
Automatic alarm to detect filter saturation

Safety Standards	AFNOR NF X 15-211:2009: France - BS 7989: England DIN 12 927:Germany - EN 1822:1998 (HEPA H14 & ULPA U17 Filters) - CE Marking
Air Flow	660 m ³ /h - 135 CFM
Air Face Velocity	0.4 to 0.6 m/s - 79 fpm to 118 fpm
Voltage/Frequency	220 V / 50-60 Hz
Power consumption	160 W
Sash openings	Total openings or new reverse sash
Structure	Corrosion resistant electro-galvanized steel coated with anti-acid polymer
Side and front panels	Chemical resistant acrylic
Filtration module	Polypropylene

Equipment

Communication interface	Simple communication by audible and light pulses: unit running time, air face velocity, automatic filter saturation detection, ventilation settings, fan failure alarm
Filtration technology	3 columns that can be configured to handle liquids, powders, or both
Carbon filtration for gases and vapours	Following filtration column configuration (see table above)
Particulate filtration for powders	Following filtration column configuration (see table above)
eGuard	APP for remote control to monitor the hood, change the settings, and deliver safety alerts immediately to your devices (mobile, tablet and PC)
Internal lighting	LED lighting > 650 Lux
Anemometer	Air face velocity alarm
Anemometer	Air face velocity indicator
Chemical Listing	List of approved chemicals

Accessories

Work Surfaces	Tempered glass / Trespa® Top LabPLUS / 304 L stainless steel
Molecode	Detection sensor for : Type S, for solvents / Type A, for acids / Type F, for formaldehydes
Benches	Fixed (Benchcap)
Bench equipment	Technical gases outlets, water outlets, front control valves, sink, power sockets (Only compatible with Trespa® Top Lab plus worktop and fixed bench)
Particulate Pre-filter	Protects the main filter(s) from dust
Transparent Back Panel	Clear acrylic panel for easy viewing



Erlab's state of the art Research & Development Laboratory relies exclusively on filtration

About Erlab

We provide safety, we protect your health

Erlab invented the ductless fume hood in 1968. With more than 50 years of experience in the field of chemical filtration and protection of laboratory personnel; we know the formula for safety. With Erlab, you will never have to wonder or worry if our products are safe. We build each one of the following 7 ingredients into our products, and without all of them, your health and safety will be compromised.

1 Erlab R&D Laboratory

The engineers and chemists in our state-of-the-art R&D laboratory understand molecular filtration. We are committed to designing products that are safe and of the highest quality, strive to improve our products, and continuously develop new products that provide greater protection in the laboratory.

2 Strict Safety Standards

We hold ourselves to the highest standard and adhere to the strict AFNOR NF X 15-211: 2009 filtration safety standard as endorsed by ANSI Z9.5-2012.

3 A Published Chemical Listing

It all begins here. Without this listing, we are not compliant with AFNOR NFX 15-211. Our in-house laboratory tests, as well as independent testing, to verify the retention capacity of over 700 chemicals for our filters.

4 Independent Testing

Erlab filters have been independently tested multiple times at various concentrations guaranteeing that our safety solutions all adhere to the strict performance criteria of the AFNOR NF X 15-211:2009 standard assuring that the emission concentration at the filter exhaust will always be lower than 1% of the TLV.

5 Application Questionnaire (Valiquest)

Our laboratory specialists will recommend the appropriate filtration fume hood, type of filter, and personalized advice.

6 Certificate of Validation for the chemicals used in the hood

A certified PhD chemist issues a Certificate of Validation with a list of the chemicals approved for use in the hood.

7 Our Safety Program

We back up our products 100%. This program includes your specialized chemical evaluation, validation of your hood upon installation, and a filtration safety specialist at your service to ensure that your hood is operating to its full potential.

France
+33 (0) 2 32 09 55 80 | ventes@erlab.net

United States
+1 800-964-4434 | captairsales@erlab.com

China
+86 (0) 512 5781 4085 | sales.china@erlab.com.cn

Spain
+34 936 732 474 | export.south@erlab.net

Germany
0800 330 47 31 | export.north@erlab.net

United Kingdom
+44 (0) 1722 341 940 | export.north@erlab.net

Italy
+39 (0) 2 89 00 771 | export.south@erlab.net